



Hawkeye 4K Split V5 AV + HDMI + UVC Cam

- Low latency TV output
 - HDMI output
 - UVC streaming
 - WDR
- 4K 50/30FPS, 1080P 100FPS
- Internal video stable/ Gyroflow
 - Distortion correction
 - Video repair
 - RC trigger to capture

V1.0

The latest Manual:

https://drive.google.com/file/d/1nod6umUkoJfHWGu9czxssqz5MpgXVG5v/view?usp=drive_link

Contents

Safety Guidelines:	3
Features :	4
Buttons:	8
Video Settings:	8
Photo Settings:.....	9
System Settings:	10
Triggers:	11
Record videos:.....	12
Transferring Files:	12
Update Firmware:.....	12

Safety Guidelines:

Please read the instruction manual carefully before using the camera for the first time.

Please check the latest version manual on our website.

- 1.It's a high-precision product, do not drop or crash it.
- 2.Do not expose the camera to strong magnetic objects, such as magnets or electrical motors. Avoid exposing the product to strong radio waves. Strong magnetic fields may cause the products breakdown or image/audio damage.
- 3.Never leave the products exposed to high temperatures and direct sunlight.
- 4.In case of overheating, smoke, or unpleasant smell, unplug your device immediately to prevent fire hazard.
- 5.Keep the product out of children's reach. Power cable may cause children accidental suffocation or electric shock.
- 6.Keep the device in cool, dry and dust-free places.
- 7.Please do not throw the product or it's battery to the garbage, find a specific recycling place for it.

Features :

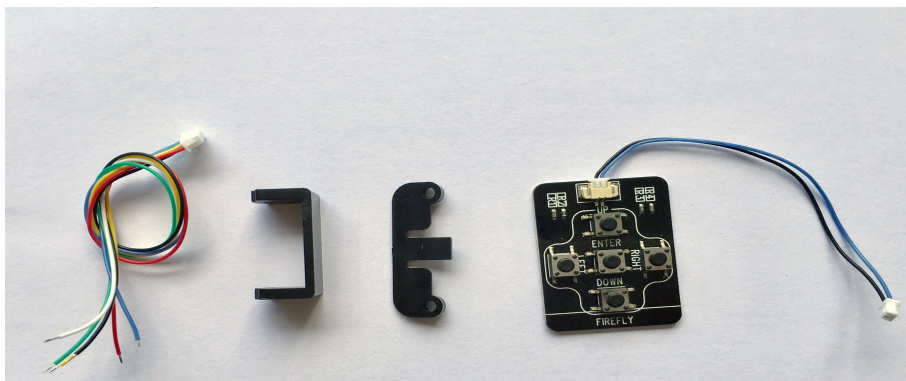
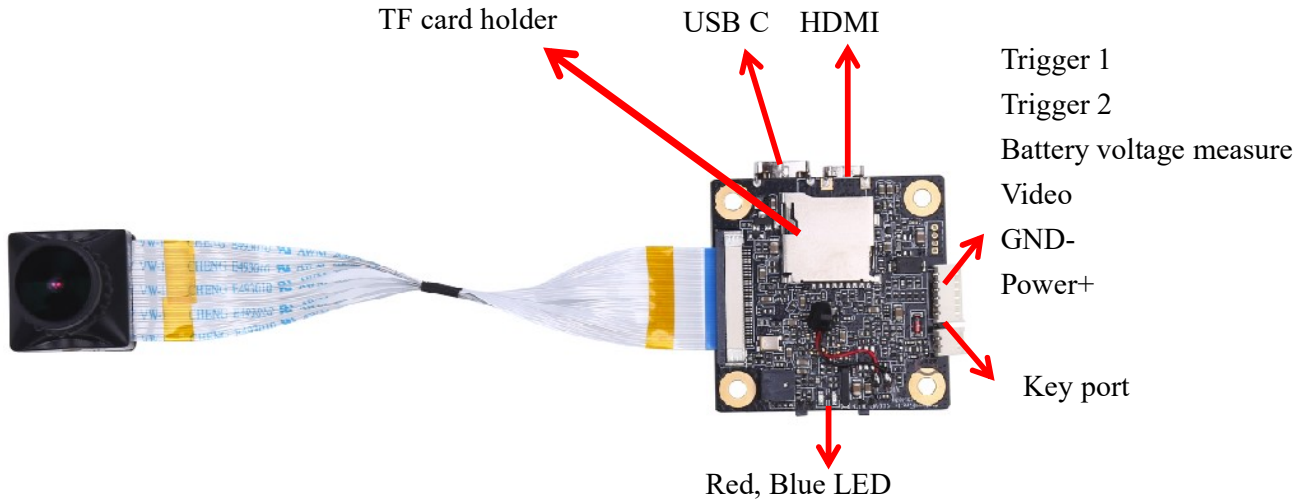

Power/video Cable Converting Mount SD Protection Cover Key board
(22 to 28mm)

SD Protection Cover:

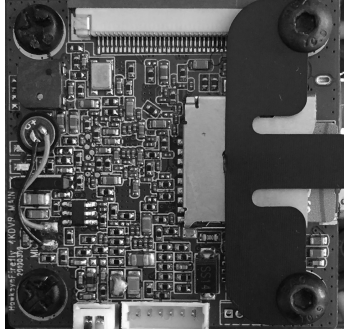

LED indicator:

resolutions	LED color
4K 50FPS	Red + Blue
2.7K 60FPS	Red
1080P 60FPS	Blue
4K 30FPS	Red

Wires:

Red: 6-24V DC input +

Black: GND

Yellow: Video Out

White: Battery detect (MAX 26V)

Blue: Video trigger

Green: Photo trigger



Note: Never connect video/trigger port to power+!!! Or they will be destroyed!

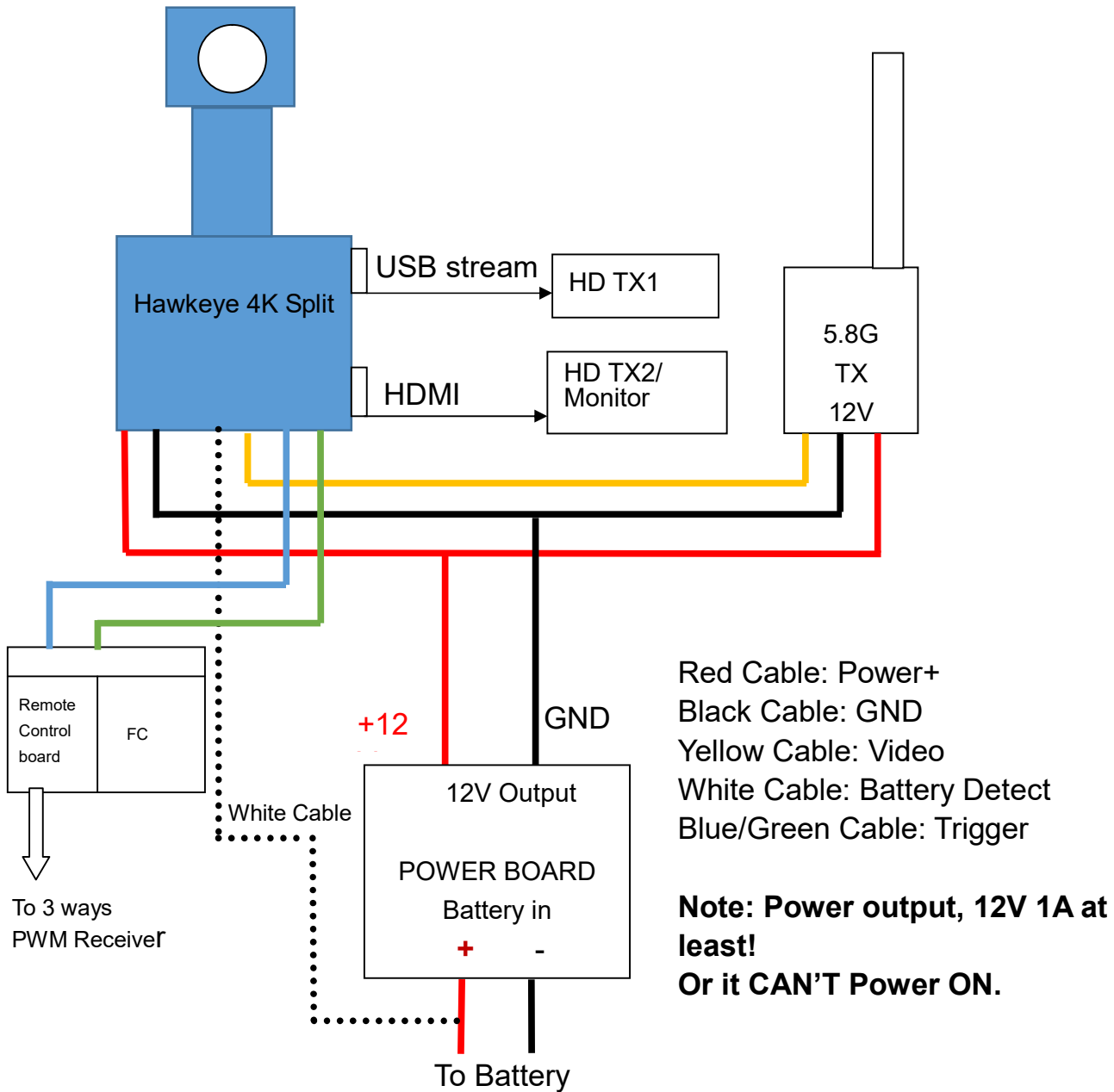

1. PC CAM resolutions:4K, 2K,1080P, 720P, VGA.
2. USB streaming (MAX 1080P), AV output, video recording at the same time..
3. HDMI and USB streaming. HDMI and USB streaming, recording can ONLY use at the same time when: HDMI output resolutions set to 720P or 4K.
4. USB streaming is not supported at photo mode, only in video mode.

Performance and Specifications:

	Resolutions	4K 50FPS(4:3 2880×2160) 4K 30FPS (3840×2160) / 1080P 100/60FPS/ 2.7K 60/30FPS/
	AV output	PAL/NTSC
	Micro SD card	U3 Sandisk recommend
	SD card supported	8-256G FAT32/exFAT
	Size	38 ×38 MM 30.5×30.5 M4 holes
	Weight	19g
	File format	*.MP4/H.265/H.264
	Lens	F/2.8 , 7 glasses
	Angle	Diagonal 170 degrees
	Voltage	6-24V
	Current	900mA

Buttons:

Name	Functions	Description
Power/ OK Button	Power ON/OFF; Start/Stop Recording	Press Once to power on; Press once to start/stop recording after power on.
Mode Button	Toggle between	Press and hold for 2 seconds to toggle different resolutions.

OSD key board:

Up button: switch to video mode

Left: Menu settings
Double click: system menu

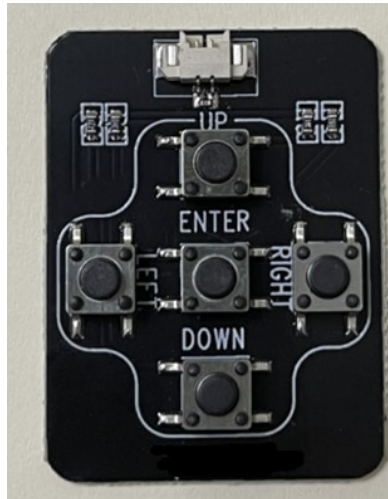

Right: Playback
Enter: OK / Record button

Down: switch to photo mode

Type C Port:

A5,B5 : TV output (16pin or 24pin)

A1	A2	A3	A4	A5	A6	A7	A8	A9	A10	A11	A12
GND	TX1+	TX1-	V _{BUS}	CC1	D+	D-	SBU1	V _{BUS}	RX2-	RX2+	GND
GND	RX1+	RX1-	V _{BUS}	SBU2	D-	D+	CC2	V _{BUS}	TX2-	TX2+	GND
B12	B11	B10	B9	B8	B7	B6	B5	B4	B3	B2	B1

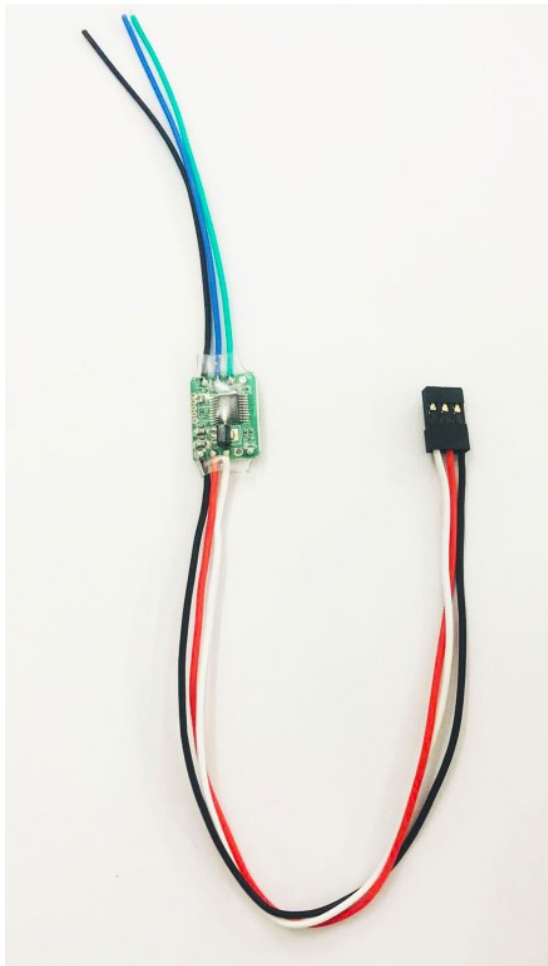
Remote control cable (Optional) :

1. DuPont head, connected to one channel PWM receiver, White (PWM signal), Red (5V), Black (Ground).
2. 3P soldering wire, connected to the camera trigger wires, black (Ground), blue (video trigger), green (photo trigger). Trigger signal, active low (>100ms)。

Video Settings:

Resolution: 4K 50fps(4:3) (2880×2160) ,4K (3840×2160) 30fps、2.7K 60fps、 2.7K 60/30(4:3)fps、 2K 60fps、 2K 30fps、 1080P 100、 1080p 60fps、 1080p 30fps.

Loop recording: Off、 3、 5、 10 minutes. When the SD card is full, video will be auto loop recording. When the SD card is full, video will be auto loop recording. The oldest file will be deleted first.

WDR: Off、 On. WDR effect will be On/Off. **Note: When this function is turned on, the image will not become dark even toward the sun. The image would not look so clear if this function is ON sometimes. As a FPV cam, this function should be turned ON.**

Exposure: +2.0、 +5/3、 +4/3、 +1.0、 +2/3、 +1/3、 0、 -1/3、 -2/3、 -1.0、 -4/3、 -5/3、 -2.0. Note: Higher value for brighter image. If you want brighter image, set this value higher. If the image is over exposure, set the value smaller.

Record Audio: Off、 On.

Date Stamp: off、 On. Set the date time stamps on the video.

EIS: Off、 Internal, Gyroflow. Gyro Image stabilization. Internal: the video will be saved as stabilized video. Gyroflow: you can use gyroflow.exe to stable the video on computer or smart phone.

Time-lapse record: Off、 0.05、 0.1、 0.5、 1、 3、 5、 10、 30、 60sec. Note: Time-lapse is a video recording mode that captures video at a very low frame rate: around one to two frames per second, although this depends on the length of the recording. When played back, time-lapse video is almost the opposite of slow motion. Higher value for shorter video. There's no voice in this mode.

Slow Motion: Off, 1080P 120. Slow motion (commonly abbreviated as slo-mo or slow-mo) is an effect in film-making whereby time appears to be slowed down.

Auto Recording: Off、 On. **Note: The camera will turn on and record automatically without pressing button. When you stop recording, you need to press the record button. When the power is suddenly cut off or the stop recording button is not pressed, the file will be damaged. You need to use the keyboard to enter the playback mode. When you play back the damaged file, the file will be repaired automatically.**

Codec: H.254、H.265.H.265 has better compression efficiency. Perhaps some players can't play the files. We recommend using **VLC** player.

Snapshot in recording: Off、5、10、30sec. Video + photo mode.

Photo Settings:

Resolution: 20M、16M、12M、10M、8M、5M.

Self Timer: 2、5、10 sec.

Quality: Fine, Normal, Economy.

Burst photo: Burst 3, Burst30.

Sharpness: Strong、Normal、Soft.

Contrast: High、Medium、Low.

Anti-shaking: Off、On.

Quick Review: Off、2、5 sec.

Date Stamp: Off、Date、Date&time. Set the day time on the image

Exposure: +2.0、+5/3、+4/3、+1.0、+2/3、+1/3、0、-1/3、-2/3、-1.0、-4/3、-5/3、-2.0.

Metering: Average、Center-weighted、Spot.

Long exposure: Off、0.5、1、2、5、10、30、60sec.Using a long-duration shutter speed to sharply capture the stationary elements of images while blurring, smearing, or obscuring the moving elements. Long-exposure photography captures one element that conventional photography does not: an extended period of time.

Note: If you turn on long exposure during the day time, it may cause the image be overexposed.

System Settings:

Date time setting. Set daytime.

Auto power off: Off、1、2、3、5、10minutes.The camera will turn off when there's no operation.

Beep sound: Off、On。 Set the beep sound on/off.

Language: Muti languages.

Frequency: 50、60HZ. Light frequency indoor. **When the video flickers indoor, change this setting.**

TV mode: PAL、NTSC. **NTSC is 30fps, PAL is 25fps. NTSC is smoother than PAL.**

HDMI out: 4K30,1080P 60/ 30、720P 60. When connect the Micro HDMI cable to a TV, the camera will switch to HDMI automatically.

Note:

1. AV and HDMI can not output at the same time. When HDMI is connected, it will switch to HDMI automatically.

2.HDMI and USB streaming. HDMI and USB streaming can ONLY use at the same time when: HDMI output resolutions set to 720P or 4K.

3. USB streaming is not supported at photo mode, only in video mode.

HDMI Forced Output: Off, On. Forced HDMI signal output, **TV output will be disable! This is for HD Transmitter.**

OSD Mode: Off、On. OSD on TV output.OSD on TV output. To disable the OSD, turn this Off.

Logo watermark: Off、On.

ISO:Auto、100、200、400、800、1600、3200. The term was carried over from film, when the ISO rating was known as the “film speed” and “ASA.” Having a standard of sensitivity is important, as it allows you to shoot the same ISO on different cameras and trust that the exposure value will be equal. Lower ISO, darker image, less noise.

Image effect: Color, Black&white, Sepia, Sketch, ColorPencil, Negative, Rock, Cool green,Warm yellow。

Scene: Auto,Portrait、Landscape.

White balance: Auto、Daylight、Cloudy、Tungsten、Fluorescent、Diving mode。White balance affects the image, warmer or cooler. Different Lens should use different white balance too. We recommend Hawkeye 4 for the stander lens.

White balance auto lock: When start recording, the current white balance will be locked.

Distortion: Off, On. Distortion Correction. Large angle lens could cause distortion at the edges of the image. Turn on to correct the distortion. The image will be cropped by 10%.

FOV: Large, Medium, Small. The field of view. Crop the edges of the video to avoid capturing the propellers.

Image rotation: Off, On. Turn the image upside down.

USB: Masstorage, PC CAM(1080P,2K, 4K).

NOTE:

2. **PC CAM resolutions:4K, 2K,1080P, 720P, VGA.**
2. **USB streaming (MAX 1080P), AV output, video recording at the same time..**
3. **HDMI and USB streaming. HDMI and USB streaming, recording can ONLY use at the same time when: HDMI output resolutions set to 720P or 4K.**
4. **USB streaming is not supported at photo mode, only in video mode.**

Format: Format the SD card. **Note: format the SD card at the first time, or the camera can't recognize the SD card. Please format to FAT32 or exFAT.**

Default settings. if you have any question, you can set to default settings.

Version. Version number. Check its the newest firmware on www.CNfpv.com.

Triggers:

The trigger pins need to be connected to the trigger control cable. Scan to watch.



Note: Don't connect the trigger pins to any power. If you want to control it by a MCU, connect it to a 3.3V GPIO through a 1K resistance.

Record videos:

Please insert SD card, then press Power/OK button once to record. Please use U3 speed SD card at least(8-258G). Format the SD card in the camera at the first time(FAT32/exFAT).

Transferring Files:

1. Connect the camera to a computer via USB cable, and then turn on the camera. When connection to computer, the camera can't record video.
2. Double click "My Computer" and locate "Removable Disk". Enter "Removable Disk" and you will find all photo and video files in the folder.

PC CAM:

There're two ways to use the camera as a PC CAM.

1. Hold M button, then connect USB to computer for about 8 seconds, the camera will enter PC CAM mode.
2. You can set USB mode (U disk or PC CAM) in the menu.

Please watch:

<https://youtube.com/shorts/iGPOdA0fMCg?feature=share>

Use AMCAP to open PC CAM.

<https://amcap.en.softonic.com/download>



Update Firmware:

1. Delete all the files and folders in the SD card(suggest:8G/16G).
2. Download the bin firmware to SD card .
3. Insert the SD card into the camera.
4. Power on the camera and it will update firmware automatically.
5. When updating, the LED will flash.
6. When the update process is finished, the LED will stop flashing.
7. The camera will reboot again.
8. Please check on www.CNfpv.com for new firmware updates.

Gyroflow iOS and Android, PC:

Please search “gyroflow: on app store for google play(1.54).

Gyroflow **1.55** android nightly build:

https://drive.google.com/file/d/1gHmF8C-gqs_9XqPbChQVJ-LdMjNdhn/view?usp=sharing





How to use Gyroflow :

IOS:

<https://youtu.be/NalAbzdivl0?si=Ji2aoBxGAELgyFMN>



1. Use sd card reader to ready the video and gyro data on the sd card, make sure they are on the same directory. **(4K 50 can not be stabled, cause no gyro data in this resolution)**

 20240311114534_202420.MP4 **Video,**
 20240311114534_202420.gcsv **Gyro file**

2. Select a video file in the sd card directory.

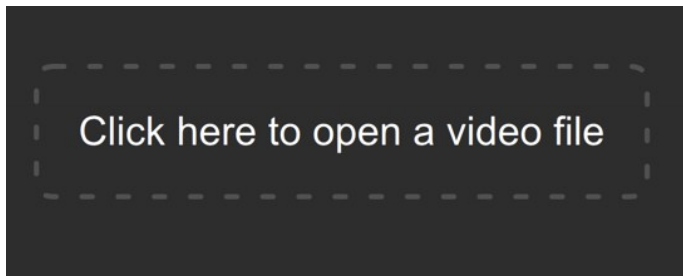

3. Click on the blue font to select the file directory for access authorization.

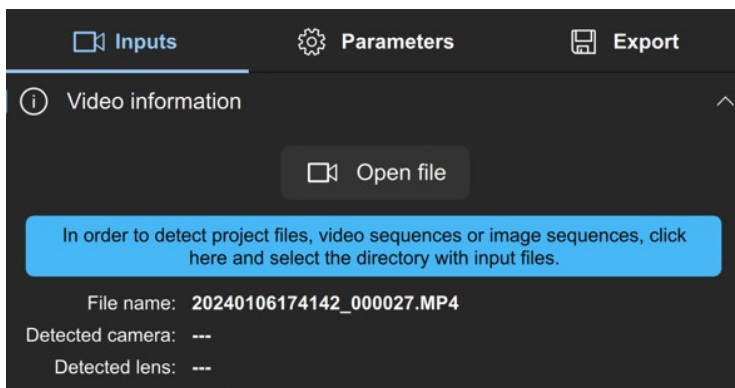

4. Click auto sync to sync the video and gyro data.

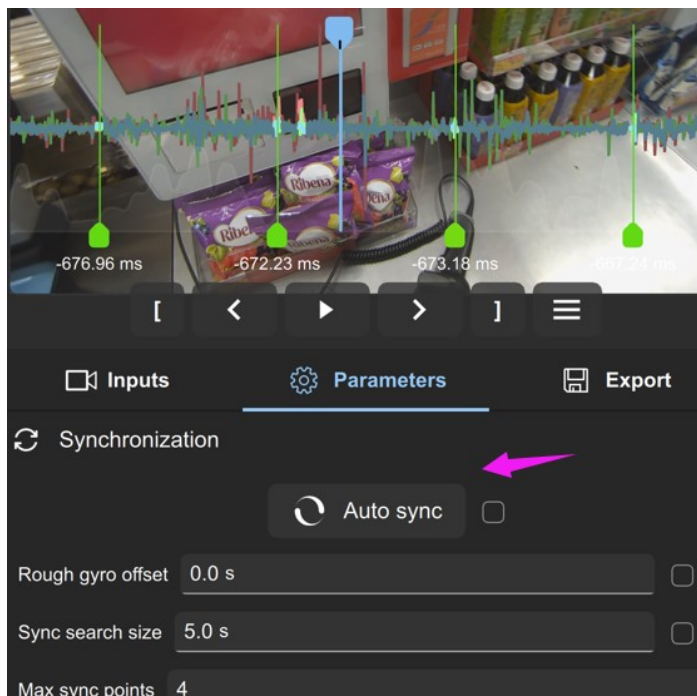

5. Export video

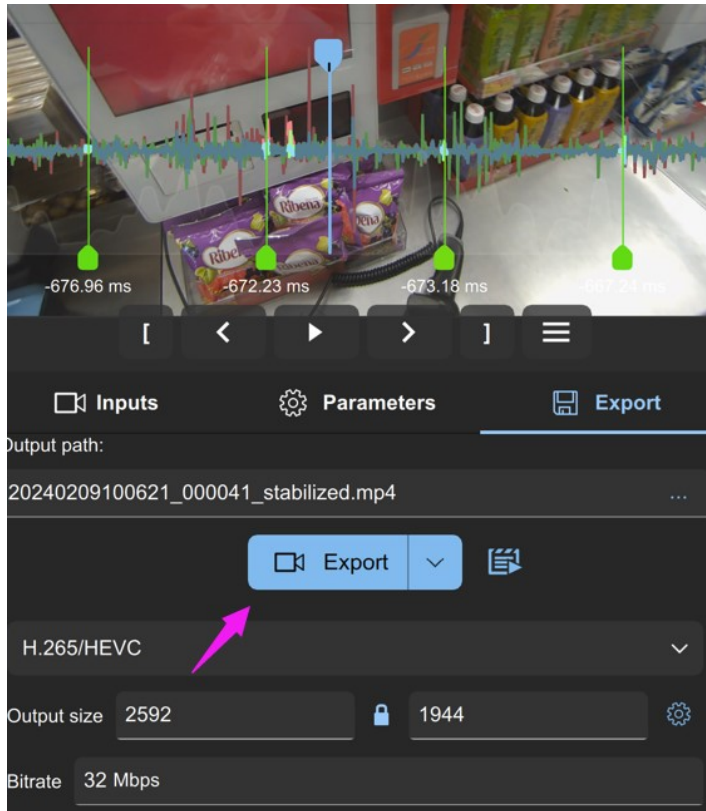

6. You can select a video clip or change resolutions to reduce the rendering time.

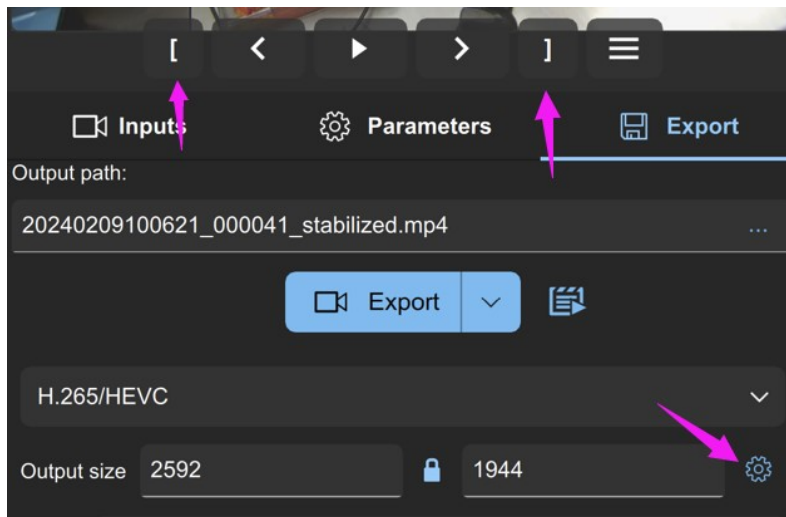



Android:

<https://youtu.be/F7fNt5FCvkQ?si=YDwFWvUEyHh5NCuf>



Use sd card reader to ready the video and gyro data on the sd card,
make sure they are on the same directory. **(4K 50 can not be stabled, cause
no gyro data in this resolution)**

1.

-  20240311114534_202420.MP4 **Video,**
-  20240311114534_202420.gcsv **Gyro file**

2. Select a video file in the sd card directory.

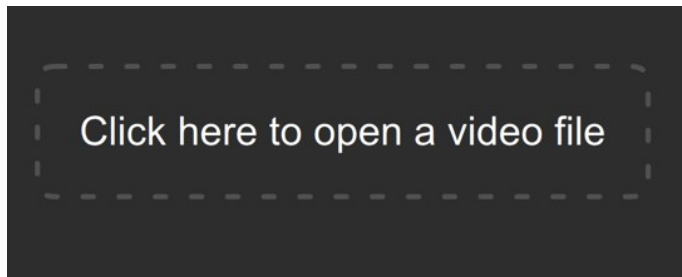

3. Click on the blue font to select the file directory for access authorization.

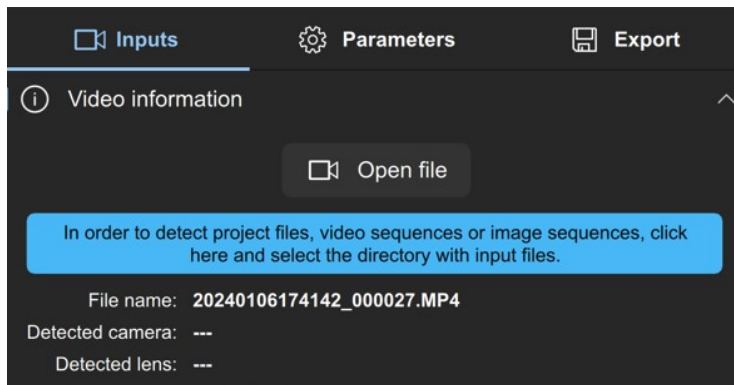

4. Input "hawkeye thumb" to select lens profile(match the resolution). (1.55 version no need this step)

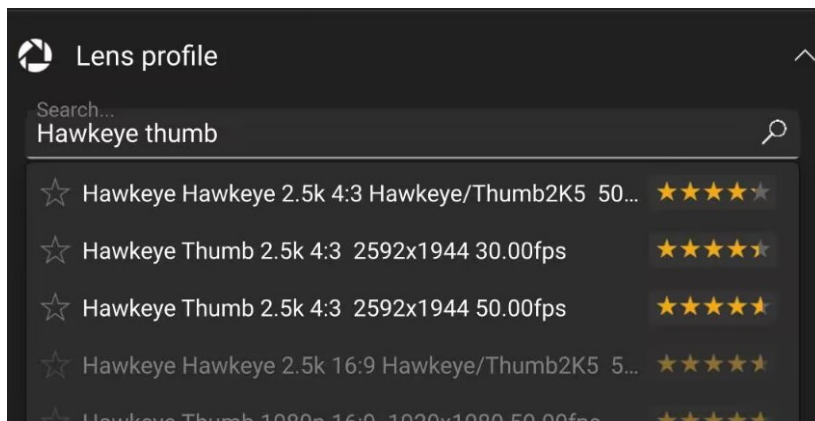

5. Load the Motion data (1.55 version no need this step):

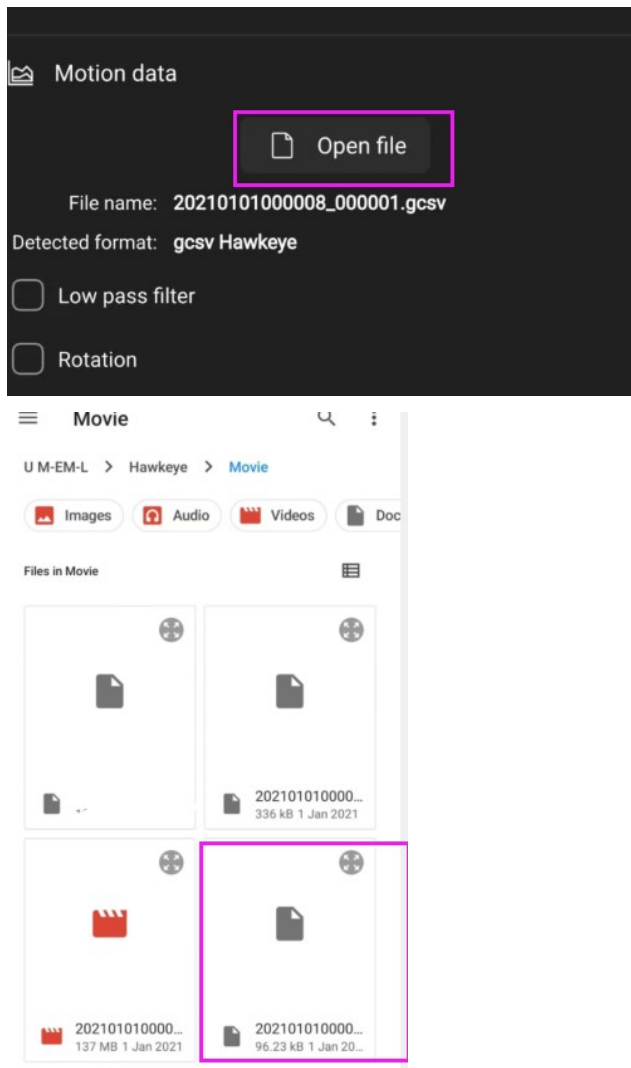

6. Click “auto sync” .

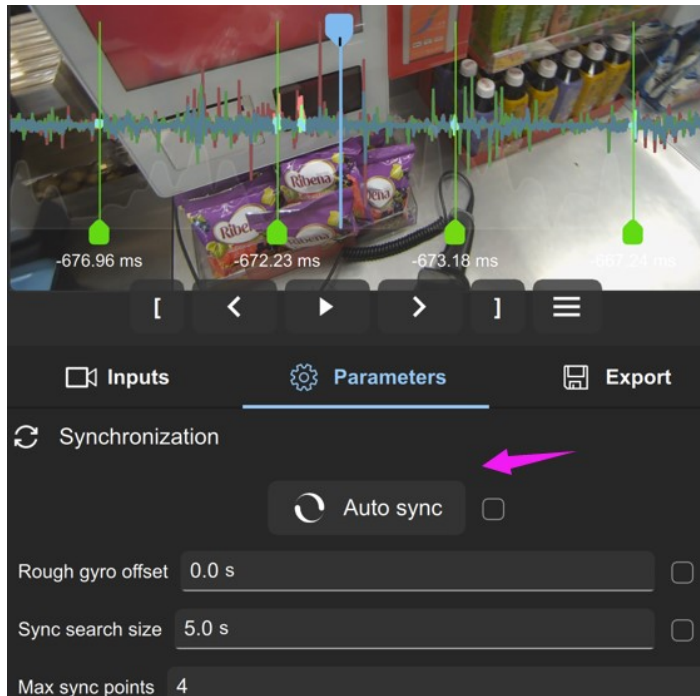

7. When finished, Export video

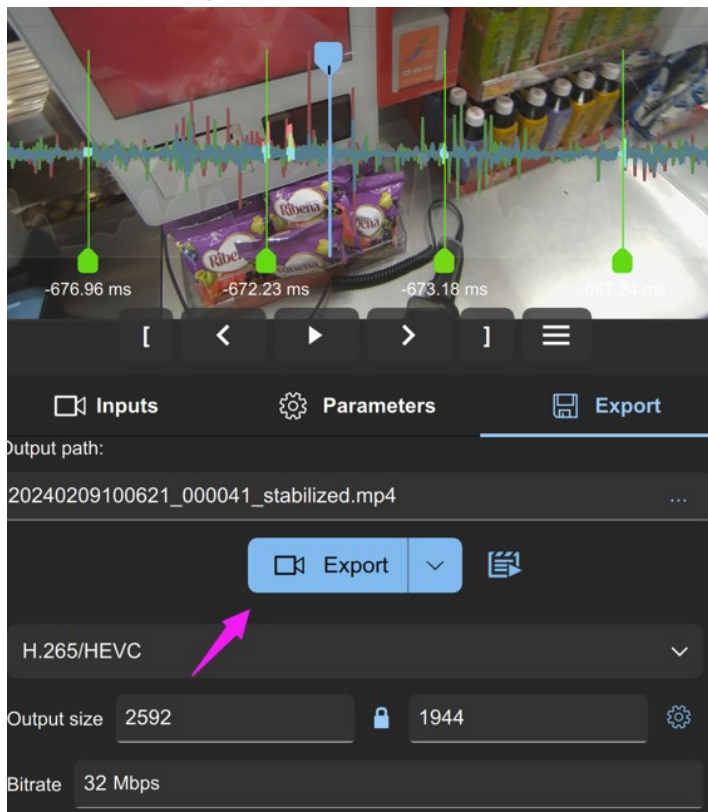

8. You can select a video clip or change resolutions to reduce the rendering time.

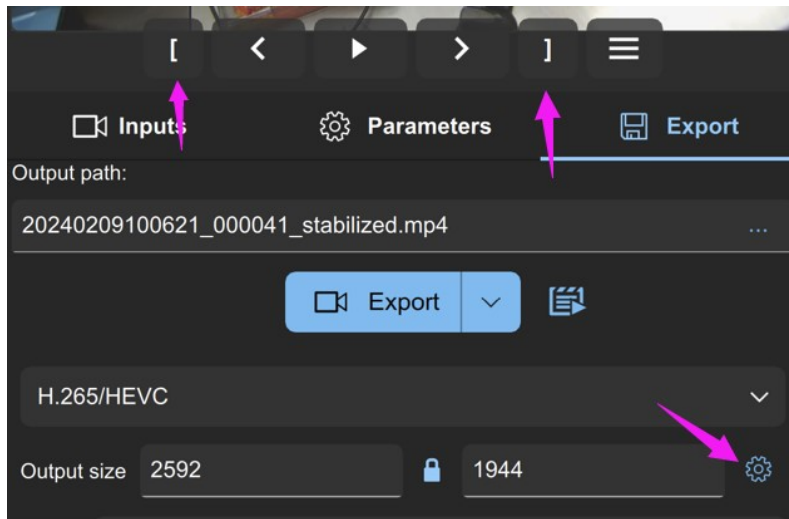

PC :

Software downloads (For WIN 10, 11):

[https://drive.google.com/file/d/1b9hHcAquPv38hZttc9Xcz6gURHscVj-k/vi
ew](https://drive.google.com/file/d/1b9hHcAquPv38hZttc9Xcz6gURHscVj-k/vi
ew)

The video and the gyro files are placed in the same directly and the file names are the same. **(4K 50 cannot be stabled, cause no gyro data in this resolution)**

1.

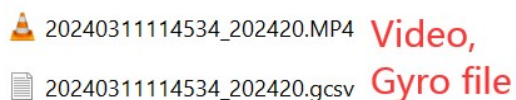

2. Double click to run gyroflow.exe and drop the video file in to the software.

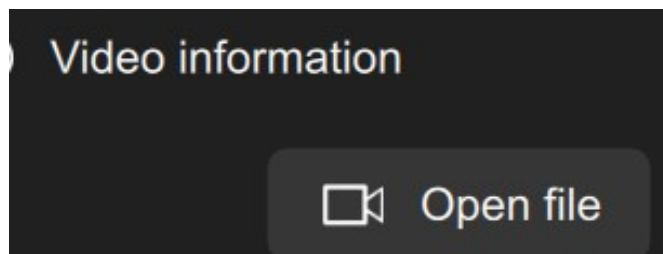

2. Sync search size: **3.5**, max sync points: **5**, then Click “Auto sync” and wait.

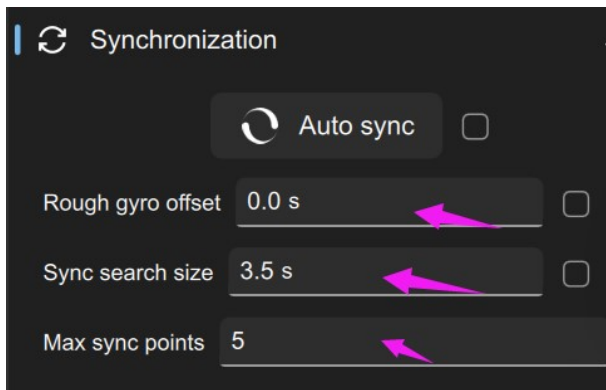

3. When the sync process is finished, export video.

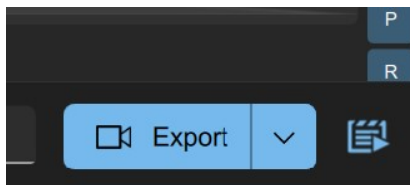

4. For saving time ,you can select a video click to output.

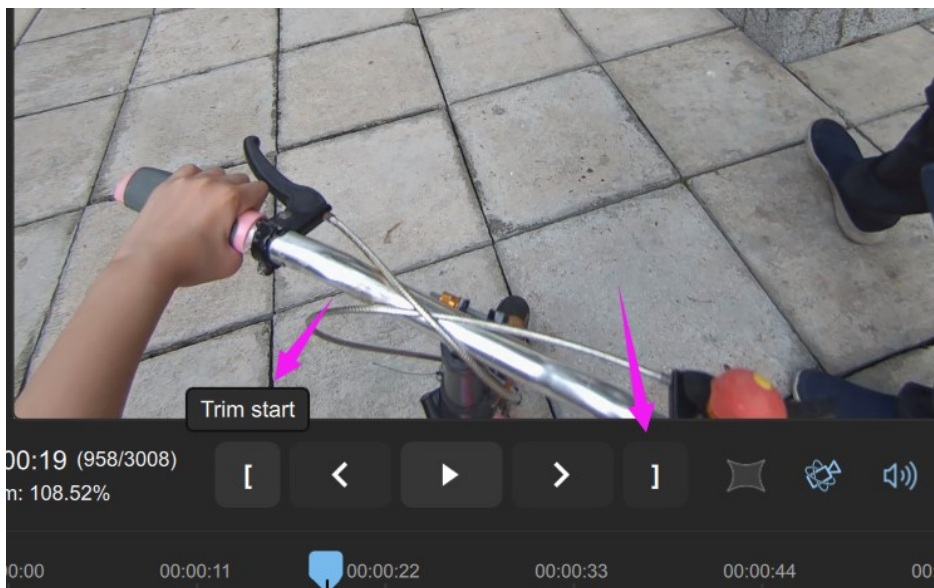

Portrait video:

When camera play in portrait, input 90 degrees in “rotation” in gyroflow:

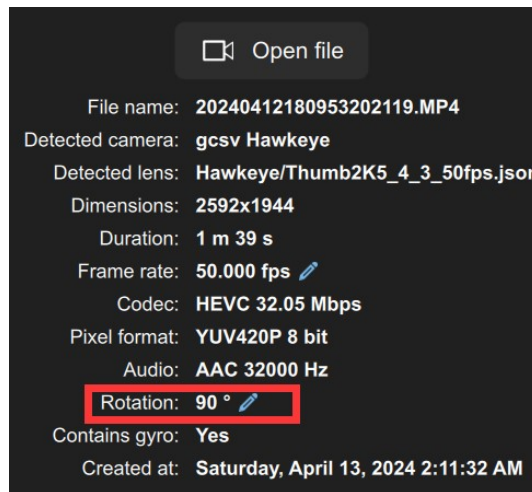
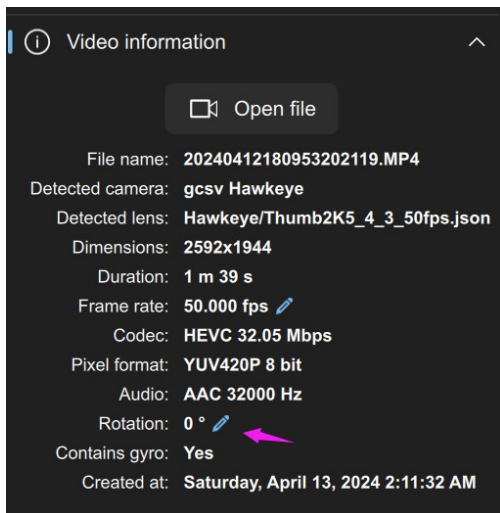

Notes for Gyroflow :

1. Sync time change to 3-5 second:

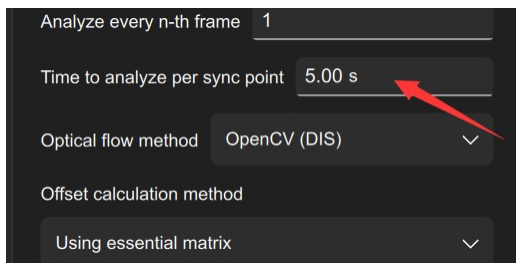

2. Use rs-sync:

3. (4K 50 can not be stabled, cause no gyro data in this resolution)

4. Select Dynamic zooming, then there will be no black side.

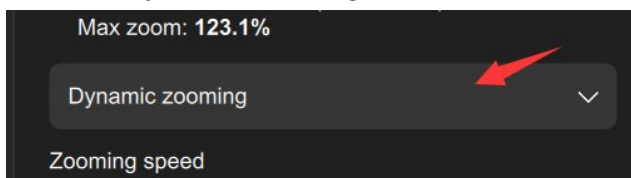

5. Sync points should be similar number, if its too different, delete it and add a sync point on other point(right click on the mouse).

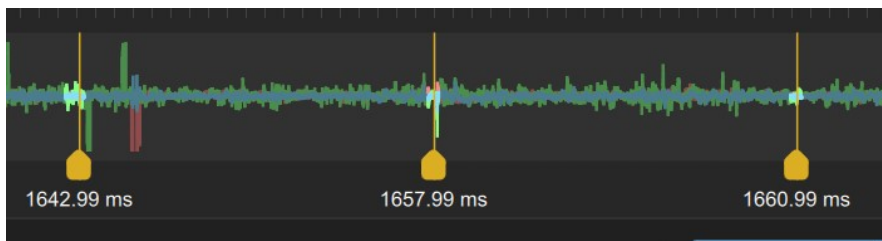

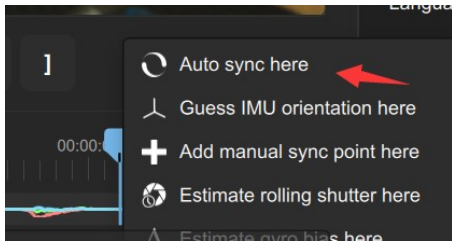

6.If can't export video , turn GPU off, change to H.264.

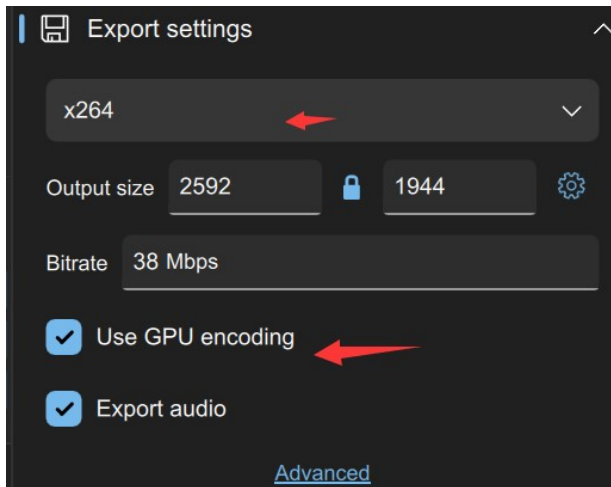

7. Software require Win 10,11. If can't open the software, install the VC pack:

VC_redist.x64.exe .

Download link : https://aka.ms/vs/17/release/vc_redist.x64.exe

8. If still can't open, you can install VC:

9. <https://visualstudio.microsoft.com/zh-hans/downloads/?cid=learn-onpage-download-cta>



10. The light dot is optical flow, you could turn it off.

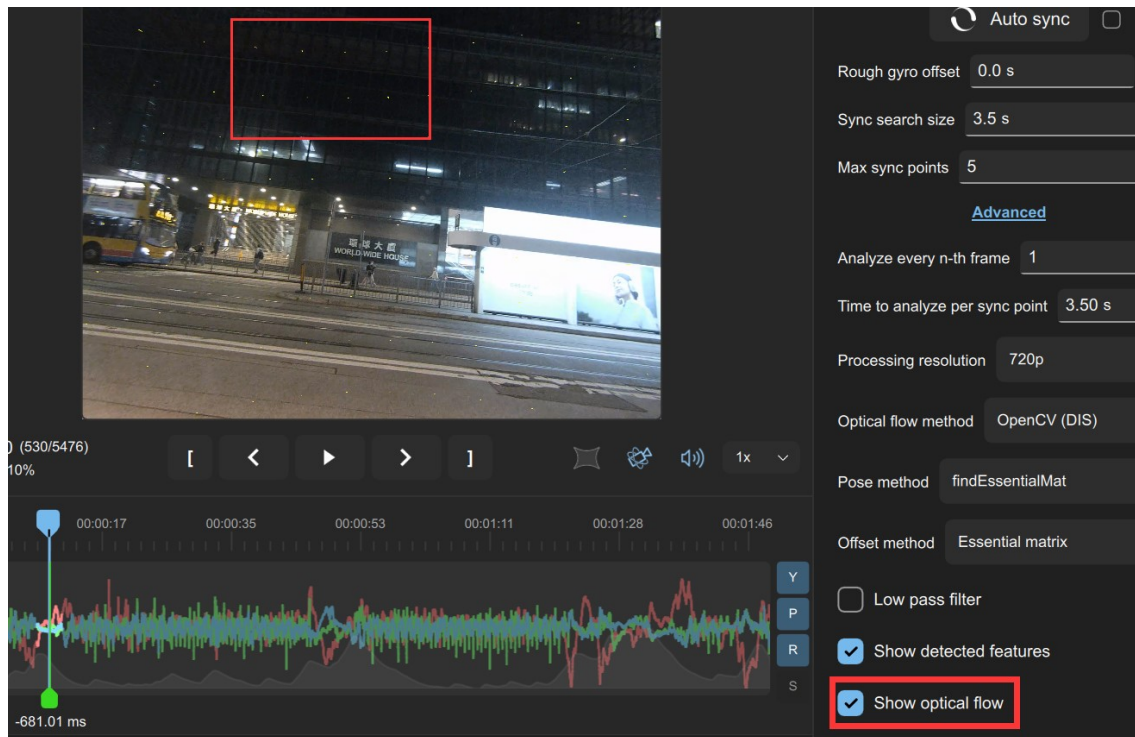

If you don't know how to setup the software, just download our preset software:

<https://drive.google.com/file/d/1b9hHcAquPv38hZttc9Xcz6gURHscVj-k/view>

FCC STATEMENT :

This equipment has been tested and found to comply with the limits for a Class B digital device, pursuant to Part 15 of the FCC Rules. These limits are designed to provide reasonable protection against harmful interference in a residential installation.

This equipment generates uses and can radiate radio frequency energy and, if not installed and used in accordance with the instructions, may cause harmful interference to radio communications. However, there is no guarantee that interference will not occur in a particular installation. If this equipment does cause harmful interference to radio or television reception, which can be determined by turning the equipment off and on, the user is encouraged to try to correct the interference by one or more of the following measures:

- Reorient or relocate the receiving antenna.
- Increase the separation between the equipment and receiver.
- Connect the equipment into an outlet on a circuit different from that to which the receiver is connected.
- Consult the dealer or an experienced radio/TV technician for help.

Changes or modifications not expressly approved by the party responsible for compliance could void the user's authority to operate the equipment.

This device complies with part 15 of the FCC Rules. Operation is subject to the following two conditions:

- (1) This device may not cause harmful interference, and
- (2) this device must accept any interference received, including interference that may cause undesired operation.

NOTE:

Check on www.CNfpv.com for new firmware/Manual updates.

For more information please check our

Youtube/Facebook/Instagram channel:

Hawkeye Firefly Official

Youtube

Facebook



Instagram

